



## REFRIGERATION DOOR GASKET PROFILE SHEET

Jeans Extrusions	RAC Profile	Fabex & CG.	Brands
10-001	m-708-001	10	Anthony
10-018	m-719-018	180	Kolpak, Welbilt, Vollrath
10-029	m-738-029	601	American Panel
10-034	m-706-034	959	True MFG
10-057	m-707-057	227	Anthony
10-101	m-717-101	221	Delfield
10-130	m-714-130	301	Hobart, Arctic Air, Vulcan-Hart, Utility
10-436	m-715-436	166	Continental, Continental, Cold Tech, Elliot Williams, Foster, Glenco, McCall, Star Metal, Tafco, Traulsen, Utility
10-508	m-740-508	85	Victory
10-516blk	m-703-516blk	164	
10-516	m-703-516	165	
10-521	M-736-558	290	Ardco, Swingline
10-588	M-754-856	385	Ardco, Enertech
289	F-772-289	289	Misc
365	m-750-365	365	Anthony (after 1981)
504	m-751-504	504	Traulsen
548	m-727-548	548	
612	m-748-612	612	Anthony (prior to 1981)
618	m-735-618	783	Delfield
697	m-731-697	697	3rd Generation Turbo Air
716	M-742-035	716	Ardco, Overly
721	F-721-804	48	Atlas Metal, Continental, Glastender, Hobart, Silver King, Utility
742	M-742-035	716	Ardco, Overly
743	M-743-206	802	Delfield
745	M-751-504	504	
748	M-748-612	612	
750	M-757-330		Beverage Air
752	M-752-091	1	
755	M-755-563	782	Anthony, Hussman
785-599	m-785-599	599	
829	m-729-892	829	Delfield
848	F-721-804	48	
852	m-747-852	852	Leer, McCall, Victory, Styleline, Zero
967	m-749-967	967	Delfield, Randell
1059	M-713-059	590	Hobart, Arctic Air, Vulcan-Hart, Utility
1086	M-762-086	1	Star/Starrett
1094	m-703-094	424	Atlas Metal, Bally, Brown, Carter-Hoffman, Evans, EverFrost Inc., Federal, Glastender, Kairak, La Rosa, Migali, Pinnacle, Stanley Knight, Traulsen, Utility, W.A. Brown
1095	M-730-544	544	Kolpak, Vollrath
1169	m-710-169	691	Traulsen
1230	m-709-230	833	Silver King
1357	m-043-357	891	Delfield
1364	M-711-364	273	Hobart, Foster
1471	m-716-471	714	Randell

 FLEXIBLE GASKET

 SANTOPRENE GASKET

Santoprene gaskets are longer lasting than standard PVC gaskets and are more durable and rated for higher temperatures. Santoprene gaskets are great for drawers and warming cabinets.

 SILICONE GASKET

Silicone gaskets are best fit for ovens as they can withstand higher temperatures than PVC or santoprene gaskets.

### How to Find the Correct Gasket:

Easily find the gasket by identifying the manufacturer of the equipment and using this key to find all compatible gaskets profiles.

Then use the pictures on the following pages and confirm it is the same as the existing worn gasket. Profiles are listed in numerical order.

Measure the gasket outside edge to outside edge to get the correct dimensions of the gasket.

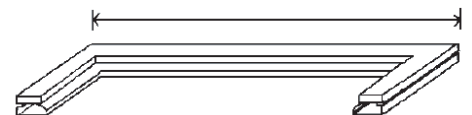

**Need help? Call  
(800) 831-9686**



# REFRIGERATION DOOR GASKET PROFILE SHEET

1515	m-726-515	254	Beverage-Air, Blue Air, Brown, Master-Bilt, Nor-Lake, 1st Generation Turbo Air
1536	m-712-536	632	Anthony
1563	m-712-536	782	Misc
1624	m-704-624	258	True MFG
1632	m-705-634	582	True MFG
5270	m-722-270	702	Randell, Bilof, Delfield, Federal, Franke, Hobart, Howard-McCray, Jordon, Kelvinator, La Rosa, Leer, Northland, Perlick, Progressive-Golden Chef, Rhodes, Schaefer, Schmidt, Tyler
5804	F-765-190	48	Misc
6449	m-702-449	494	Acme, Continental, Delfield, Duke, Dunhill, Federal, Franke, Hobart, Howard-McCray, Jordon, Kelvinator, Kolpak, La Rosa, Leer, Master-Bilt, Nor-Lake, Northland, Perlick, Progressive-Golden Chef, Randell, Rhodes, Schaefer, Schmidt, Traulsen, Tyler, Utility,
6601	m-761-601	16	Victory, Norlake, Migali, Star, Starret
	m-213-019		Delfield
	m-701-156		American Panel, Arctic Air, Atlas Metal, Beverage-Air, Cold Tech, Continental, Delfield, Duke, Federal, Florida Stainless, Franke, Glastender, Glenco, Harford, Hobart, Hoshizaki, Howard McCray, Hussman, International Cold Storage, Jordon, Kairak, Kelvinator, Kolpak, Leer, Manitowoc, Master-Bilt, McCall, Migali, Norlake, Perlick, Progressive-Golden Chef, Randell, Schaefer, Schmidt, Stanley Knight, Star Metal, Thermo-Kool, Traulsen, Tyler, Universal Nolin, Victory, Vollrath
	m-720-509		Styleline
	m-724-823		Electrolux
	m-728-715		Randell
	m-733-677		Hoshizaki
	m-734-720		True MFG
	m-737-670		Jade, Utility, Polar King, Elliot Williams
	m-739-012		Victory
	m-741-683		Delfield
	m-744-110		Traulsen
	m-745-567		WA Brown
	m-764-606		Victory
	m-756-EVG		Misc



**FLEXIBLE GASKET**



**SANTOPRENE GASKET**

Santoprene gaskets are longer lasting than standard PVC gaskets and are more durable and rated for higher temperatures. Santoprene gaskets are great for drawers and warming cabinets.



**SILICONE GASKET**

Silicone gaskets are best fit for ovens as they can withstand higher temperatures than PVC or santoprene gaskets.

## How to Find the Correct Gasket:

Easily find the gasket by identifying the manufacturer of the equipment and using this key to find all compatible gaskets profiles.

Then use the pictures on the following pages and confirm it is the same as the existing worn gasket. Profiles are listed in numerical order.

Measure the gasket outside edge to outside edge to get the correct dimensions of the gasket.

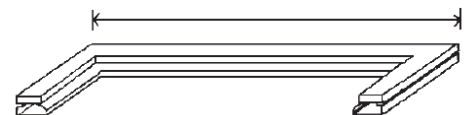

**Need help? Call  
(800) 831-9686**



# REFRIGERATION DOOR GASKET PROFILE SHEET

	m-763-119		Star/Starrett
	m-769-516BB		* big baffle, extended reach replacement for M-701-516
	m-771-060		Amerikooler
	m-773-910		Taylor (Orange Juice Machine)
	m-774-900		* big baffle, extended reach replacement for M-702-449
	m-777-619		
	m-778-CDS		Commercial Display Doors
	m-780-095		heavy duty replacement for M-703-094
	m-781-358		* big baffle, extended reach Delfield replacement
	m-784-109		Delfield, Victory
	m-785-998		Arctic Air Avantco Atos
	m-786-243		Turbo Air
	m-789-631		Everest
	m-790-714		Coldmatic *** dart is 7/16" wide ***
	m-791-337		2nd Generation Turbo Air
	m-792-196		Forma-Kool
	m-794-598		Artic Air
	m-861-602		True, Bev Air, Victory, Norlake, Migali, Star Starrett
	m-864-308		Henny Penny
	m-865-191		Misc
	m-893-311		Misc
	m-876-829		Misc
	m-821-805		
	m-807-058		Anthony
	m-829-892		Delfield
	m-824-EZ2		Traulsen EZ
	m-817-560		Delfield
	m-809-834		Silver King
	m-805-635		True MFG
	m-802-368		Misc
	m-801-042		Misc
	AS-3346-G		Alto-Shaam
	AS-3347-P		Alto-Shaam
	V-1604 Clear		Vendo
	W-3401		Winston
	W-3620		NU-VU

## FLEXIBLE GASKET

## SANTOPRENE GASKET

Santoprene gaskets are longer lasting than standard PVC gaskets and are more durable and rated for higher temperatures. Santoprene gaskets are great for drawers and warming cabinets.

## SILICONE GASKET

Silicone gaskets are best fit for ovens as they can withstand higher temperatures than PVC or santoprene gaskets.

## How to Find the Correct Gasket:

Easily find the gasket by identifying the manufacturer of the equipment and using this key to find all compatible gaskets profiles.

Then use the pictures on the following pages and confirm it is the same as the existing worn gasket. Profiles are listed in numerical order.

Measure the gasket outside edge to outside edge to get the correct dimensions of the gasket.

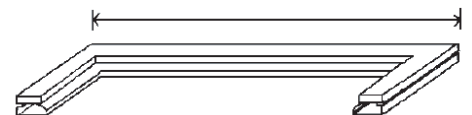

**Need help? Call  
(800) 831-9686**

**M-043-357**

**Alternate Profile**  
#s: 1357, 891, 2074

**Common Fits:**  
Delfield

**M-213-019**

**Alternate Profile**  
#s: 019

**Common Fits:**  
Delfield

**M-701-516**

**Alternate Profile**  
#s: 10-516, 167, 9532, 9510

**Common Fits:**  
Bev Air, Hobart, Norlake, McCall, Kolpak, Volrath, Vulcan, Victory, Traulsen

**M-702-449**

**Alternate Profile**  
#s: 6449, 494, 2250, 2196

**Common Fits:**  
Acme, Continental, Delfield, Duke, Dunhill, Federal, Franke, Hobart, Howard-McCray, Jordon, Kelvinator, Kolpak, La Rosa, Leer, Master-Bilt, Nor-Lake, Northland, Perlick, Progressive-Golden Chef, Randell, Rhodes, Schaefer, Schmidt, Traulsen, Tyler, Utility.

**M-703-094**

**Alternate Profile**  
#s: 1094, 424, 2208

**Common Fits:**  
Atlas Metal, Bally, Brown, Carter-Hoffman, Evans, EverFrost Inc., Federal, Gastender, Kairak, La Rosa, Migali, Pinnacle, Stanley Knight, Traulsen, Utility, W.A. Brown

**M-703-516**

**Alternate Profile**  
#s: 165

**Common Fits:**

**M-704-624**

**Alternate Profile**  
#s: 1364, 273, 2327

**Common Fits:**  
Hobart, Foster

**M-705-634**

**Alternate Profile**  
#s: 1634, 582, 902, 2563

**Common Fits:**  
True

**F-706-034**

**Alternate Profile**  
#s: 995, 10-034

**Common Fits:**  
True MFG

**M-707-057**

**Alternate Profile**  
#s: 10-057, 226, 101

**Common Fits:**  
Anthony

**M-708-001**

**Alternate Profile**  
#s: 1001, 010, 2260

**Common Fits:**  
Anthony

**M-709-230**

**Alternate Profile**  
#s: 833

**Common Fits:**  
Silver King

**M-710-169**

**Alternate Profile**  
#s: 1169, 691, 2213

**Common Fits:**  
Traulsen

**M-711-364**

**Alternate Profile**  
#s: 1364, 273, 2327

**Common Fits:**  
Hobart, Foster

**M-712-536**

**Alternate Profile**  
#s: 1536, 632, 2263

**Common Fits:**  
Anthony

**M-713-059**

**Alternate Profile**  
#s: 1059, 590, 2211

**Common Fits:**  
Hobart, Arctic Air, Vulcan-Hart, Utility

**M-714-130**

**Alternate Profile**  
#s: 10-130, 301, 9539

**Common Fits:**  
Hobart, Arctic Air, Vulcan-Hart, Utility

**M-715-436**

**Alternate Profile**  
#s: 10-436, 166, 9527

**Common Fits:**  
Continental, Continental, Cold Tech, Elliot Williams, Foster, Glenco, McCall, Star Metal, Tafoo, Traulsen, Utility

**M-716-471**

**Alternate Profile**  
#s: 1471, 714, 2257

**Common Fits:**  
Randell

**M-717-101**

**Alternate Profile**  
#s: 10-101, 221, 2039, 9542

**Common Fits:**  
Delfield

**M-719-018**

**Alternate Profile**  
#s: 10-018, 180, 9525

**Common Fits:**  
Kolpak, Welbilt, Vollrath

**M-720-509**

**Alternate Profile**  
#s:

**Common Fits:**  
Styleline

**F-721-804**

**Alternate Profile**  
#s: 5804, 2396

**Common Fits:**  
Atlas Metal, Continental, Gastender, Hobart, Silver King, Utility

**M-722-270**

**Alternate Profile**  
#s: 5270, 702, 10095

**Common Fits:**  
Randell, Bilof, Delfield, Federal, Franke, Hobart, Howard-McCray, Jordon, Kelvinator, La Rosa, Leer, Northland, Perlick, Progressive-Golden Chef, Rhodes, Schaefer, Schmidt, Tyler

FLEXIBLE GASKET
SANTOPRENE GASKET
SILICONE

## M-724-823

Alternate Profile  
#s:

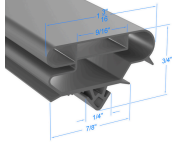

Common Fits:  
Electrolux

## M-726-515

Alternate Profile  
#s: 1515, 254,  
5361, 2425

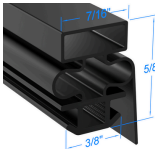

Common Fits:  
Beverage-Air, Blue Air,  
Brown, Master-Bilt,  
Nor-Lake, 1st  
Generation Turbo Air

## M-727-548

Alternate Profile  
#s: 548

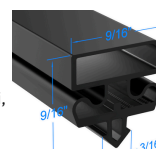

Common Fits:  
Delfield, Hoshizaki,  
Styleline, Victory

## M-728-715

Alternate Profile  
#s: 715

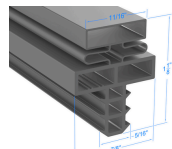

Common Fits:  
Randell

## M-729-892

Alternate Profile  
#s: 892

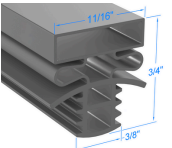

Common Fits:  
Delfield

## M-730-544

Alternate Profile  
#s: 1095, 544

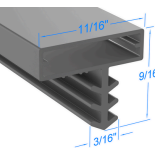

Common Fits:  
Kolpak, Vollrath

## M-731-697

Alternate Profile  
#s: 697

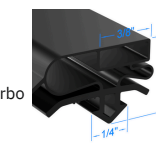

Common Fits:  
3rd Generation Turbo  
Air

## M-733-677

Alternate Profile  
#s: 677

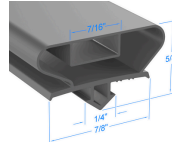

Common Fits:  
Hoshizaki

## M-734-720

Alternate Profile  
#s: 720

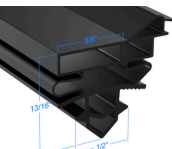

Common Fits:  
True

## M-735-618

Alternate Profile  
#s: 618

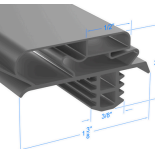

Common Fits:  
Delfield

## M-736-558

Alternate Profile  
#s: 10-558, 290,  
9535

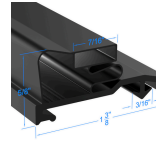

Common Fits:  
Ardco, Swingline

## M-737-670

Alternate Profile  
#s: 6670

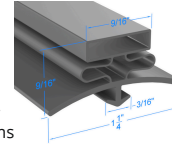

Common Fits:  
Jade, Utility, Polar  
King, Elliot Williams

## M-738-029

Alternate Profile  
#s: 10-029, 601,  
9566

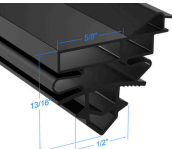

Common Fits:  
American Panel

## M-739-012

Alternate Profile  
#s: 10-012

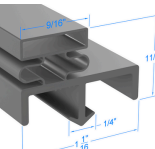

Common Fits:  
Victory

## M-740-508

Alternate Profile  
#s: 10-508, 085,  
9555

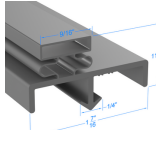

Common Fits:  
Victory

## M-741-683

Alternate Profile  
#s: 3683, 10-035

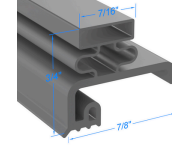

Common Fits:  
Victory

## M-742-035

Alternate Profile  
#s: 716, 5583,  
9101

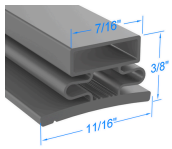

Common Fits:  
Ardco, Overly

## M-743-206

Alternate Profile  
#s: 1206, 802

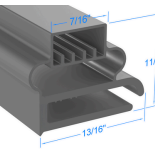

Common Fits:  
Delfield

## M-744-110

Alternate Profile  
#s: 44110

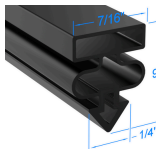

Common Fits:  
Traulsen

## M-745-567

Alternate Profile  
#s: 567

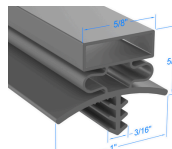

Common Fits:  
WA Brown

## M-746-606

Alternate Profile  
#s: 6606

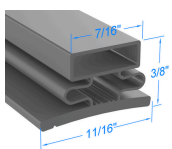

Common Fits:  
Victory

## M-747-852

Alternate Profile  
#s: 10-580, 852,  
2285

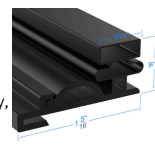

Common Fits:  
Leer, McCall, Victory,  
Styleline, Zero

## M-748-612

Alternate Profile  
#s: 612, 3598

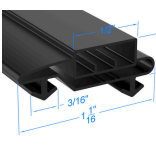

Common Fits:  
Anthony (prior to  
1981)

## M-749-967

Alternate Profile  
#s: 967

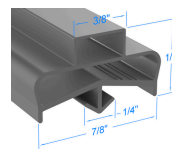

Common Fits:  
Delfield, Randell

FLEXIBLE GASKET

SANTOPRENE GASKET

SILICONE

## M-750-365

**Alternate Profile**  
#s: 365, 3597

**Common Fits:**  
Anthony  
(after 1981)

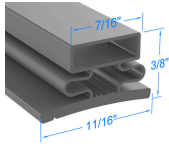

## M-751-504

**Alternate Profile**  
#s: 1504

**Common Fits:**  
Traulsen

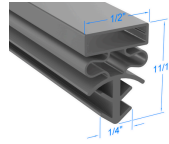

## M-752-091

**Alternate Profile**  
#s: 10-091

**Common Fits:**  
Bev Air, Glastender,  
Norlake

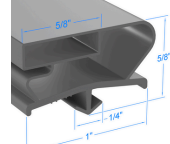

## M-754-856

**Alternate Profile**  
#s: 3856, 385

**Common Fits:**  
Ardco, Enertech

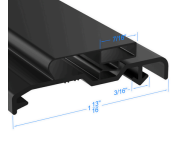

## M-755-563

**Alternate Profile**  
#s: 1563, 782,  
2278

**Common Fits:**  
Anthony,  
Hussman

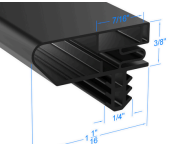

## M-756-EVG

**Alternate Profile**  
#s: 10-099  
EVGSK

**Common Fits:**  
Misc.

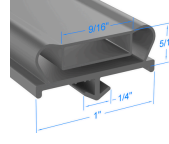

## M-757-330

**Alternate Profile**  
#s: 2330, 750

**Common Fits:**  
Beverage Air

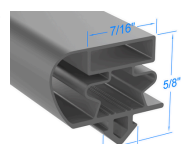

## M-761-601

**Alternate Profile**  
#s: 6601, 016,  
2209

**Common Fits:**  
Victory, Norlake,  
Migali, Star, Starret

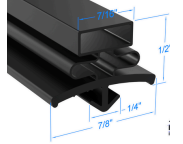

## M-762-086

**Alternate Profile**  
#s: 1086

**Common Fits:**  
Star/Starrett

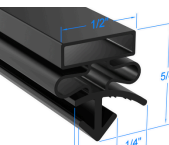

## M-763-119

**Alternate Profile**  
#s:

**Common Fits:**  
Star/Starrett

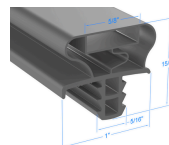

## F-765-190

**Alternate Profile**  
#s: 35-190

**Common Fits:**  
Misc.

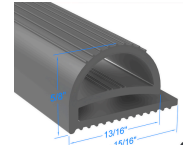

## M-769-516BB

**Alternate Profile**  
#s: 165

**Common Fits:**  
\* big baffle, extended  
reach replacement for  
M-701-516

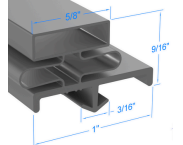

## F-771-619

**Alternate Profile**  
#s: 10-060

**Common Fits:**  
Amerikooler

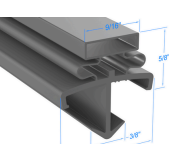

## F-772-289

**Alternate Profile**  
#s: 289

**Common Fits:**  
Misc.

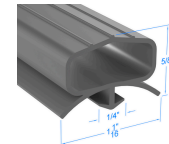

## F-773-910

**Alternate Profile**  
#s: 910

**Common Fits:**  
Taylor (Orange  
Juice Machine)

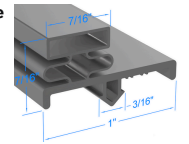

## F-774-900

**Alternate Profile**  
#s: \* M-702-449

**Common Fits:**  
\* big baffle,  
extended reach  
replacement for M-  
702-449

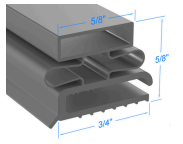

## F-777-619

**Alternate Profile**  
#s: 619

**Common Fits:**  
Delfield

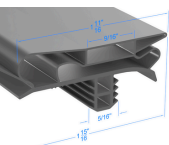

## F-778-CDS

**Alternate Profile**  
#s:

**Common Fits:**

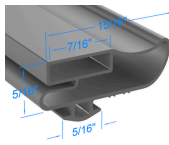

## F-780-095

**Alternate Profile**  
#s: \* M-703-094  
1094, 424, 2208

**Common Fits:**  
heavy duty  
replacement for  
M-703-094

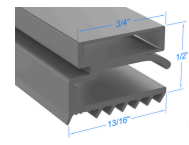

## F-781-358

**Alternate Profile #s:**  
\* M-043-357 \* M-  
729-892 \* M-735-  
618

**Common Fits:**  
\* big baffle,  
extended reach  
Delfield  
replacement

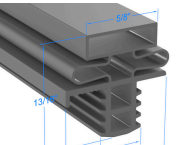

## F-782-095

**Alternate Profile**  
#s: 02-095

**Common Fits:**  
Misc

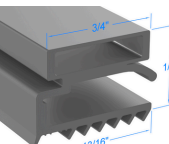

## F-784-109

**Alternate Profile**  
#s: \* M-727-548  
548 w/ flap

**Common Fits:**  
Delfield, Victory

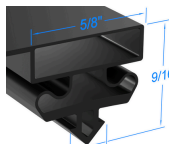

## M-785-998

**Alternate Profile**  
#s: 599

**Common Fits:**  
Arctic Air Avantco  
Atos

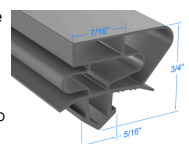

## M-786-243

**Alternate Profile**  
#s:

**Common Fits:**  
Turbo Air

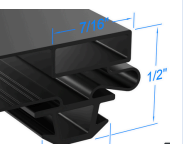

**FLEXIBLE GASKET**

**SANTOPRENE GASKET**

**SILICONE**

**M-789-631**

Alternate Profile #s: 2613

Common Fits: Delfield

**M-790-714**

Alternate Profile #s:

Common Fits: Coldmatic\*\*\* dart is 7/16" wide\*\*\*

**M-791-377**

Alternate Profile #s:

Common Fits: 2nd Generation Turbo Air

**M-792-196**

Alternate Profile #s:

Common Fits: Forma-Kool

**M-794-598**

Alternate Profile #s: 598

Common Fits: Artic Air

**M-801-042**

Alternate Profile #s:

Common Fits: Misc

**M-802-368**

Alternate Profile #s:

Common Fits: Misc

**M-805-635**

Alternate Profile #s:

Common Fits: True

**M-807-058**

Alternate Profile #s:

Common Fits: Anthony

**M-809-834**

Alternate Profile #s:

Common Fits: Silver King

**M-817-560**

Alternate Profile #s:

Common Fits: Delfield

**M-821-805**

Alternate Profile #s:

Common Fits:

**M-824-EZ2**

Alternate Profile #s:

Common Fits: Traulsen EZ

**M-829-892**

Alternate Profile #s:

Common Fits: Delfield

**M-861-602**

Alternate Profile #s:

Common Fits: True, Bev Air, Victory, Norlake, Migali, Star Starret

**M-864-308**

Alternate Profile #s:

Common Fits: Henny Penny

**M-865-191**

Alternate Profile #s:

Common Fits: Misc

**M-876-829**

Alternate Profile #s:

Common Fits: Misc

**M-893-311**

Alternate Profile #s:

Common Fits: Misc

**AS-3347-P**

Alternate Profile #s: 3347

Common Fits: Alto Shaam

**AS-3346-G**

Alternate Profile #s: 3346

Common Fits: Alto Shaam

**V-1604**

Alternate Profile #s: Bubble-Seal

Common Fits: Vendo

**W-3401**

Alternate Profile #s: 3401

Common Fits: Winston

**W-3620**

Alternate Profile #s: 3346

Common Fits: NU-VU

# HOW TO MEASURE A GASKET

## Corner to Corner

The easiest way to measure your existing gasket is to measure Outside Edge to outside edge to the closest 1/8th inch.

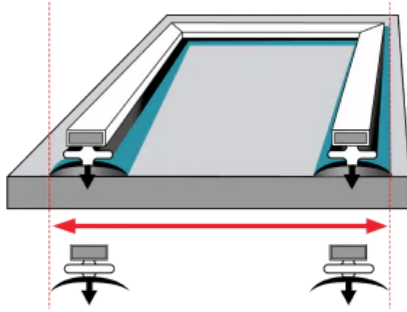

## Corner to Corner

The easiest way to measure your existing gasket is to measure Outside Edge to outside edge to the closest 1/8th inch.

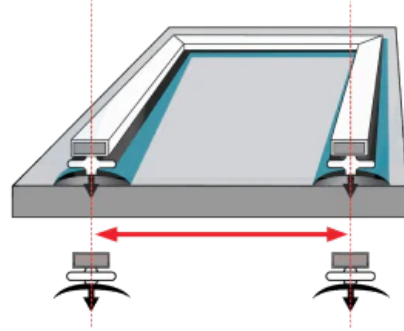

## Gasket Mounting Style

### Snap On

Snap On Gaskets are held on the door using a Dart (Arrow) The dart "Snaps" into a track on the door.



### Push In

Push in gaskets are held on the door with a barbed insert that smashes into the door track.



### Bolt On

Bolt On gaskets are held on the door with a metal plate and screws.



## Where to Locate Your Coolers Model & Serial Number

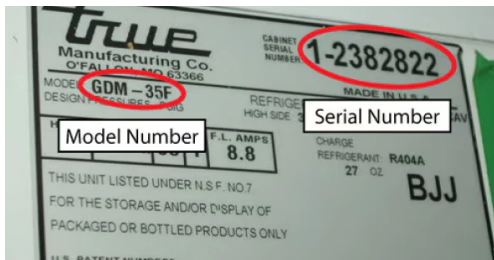

If you are unsure where to begin your search to find a replacement gasket, start by locating the data plate on your cooler or freezer. Most data plates can be found by looking inside your unit on one of the interior side walls. Once you have located the model and serial, you can call the manufacturer and request the parts department. Many manufacturers will be able to look up the gasket part number with the model and serial number. Search the part number they give you in our search bar at the top of our website. If you have the OEM part number from the factory and are having troubles locating it on our site, please contact us at (727-422-1118) and we will assist in locating the correct gasket for you.

If you are having trouble locating the data plate on your unit or locating the model/serial numbers on your data plate it is possible that it has been rubbed off or removed. Sometimes abrasive cleaning solutions are used and that could result in missing data plates or illegible model/serial numbers. If you have looked all over your unit and can't find any information as to what your model and serial number are, please visit our "Build you own Gasket" section to build your own replacement gasket.